

# User's Manual

X6RP5551

X6RP5561

X6RP5571

X6PR5551

X6PR5561

X6PR5571

## Notice

The information in this user's manual is protected by copyright laws, all parts of this manual, including the products and software described in it, can not be reproduced, transmitted, transcribed, stored in a retrieval system, nor translated into any language.

THE MANUFACTURER OR RESELLER SHALL NOT BE LIABLE FOR ERRORS OR OMISSIONS CONTAINED IN THIS MANUAL AND SHALL NOT BE LIABLE FOR ANY CONSEQUENTIAL DAMAGES, WHICH MAY RESULT FROM THE PERFORMANCE OR USE OF THIS MANUAL.

The illustrations in this user's manual are for reference only.  
Actual product specifications may vary with territories.

The information in this user's manual is subject to change without notice.

# TABLE OF CONTENTS

Notice .....	2
Preface.....	5
1.1 Regulations Information.....	6
1.2 Safety Instructions .....	10
1.3 Conventions for this Manual .....	11
1.4 Release History.....	12
Getting to know the basics.....	13
2.1 Product Specification.....	14
2.2 Preparing your Computer .....	18
2.3 Product Overview .....	19
Getting started.....	29
3.1 AC Adapter.....	30
3.2 Knowing the Keyboard .....	31
3.2.1 For keyboard users .....	32
3.3 Using the touchpad / clickpad .....	35
BIOS setup.....	38

4.1 About BIOS Setup.....	39
4.1.1 When to Use BIOS Setup ? .....	39
4.1.2 How to Run BIOS Setup ? .....	39
4.2 BIOS Setup Menu.....	40
4.2.1 Main Menu .....	41
4.2.2 Advanced Menu .....	43
4.2.3 Security Menu .....	44
4.2.4 Boot Menu.....	46
4.2.5 Exit Menu .....	47

## Chapter 1

# Preface

# 1.1 Regulations Information

α CE compliance

This device is classed as a information technology equipment (ITE) in class B and is intended for use in living room and office. The CE-mark approves the conformity by the EU-guidelines:

- EMC Directive 2014/30/EU,
- Low Voltage Directive 2014/35/EU ,
- RF Directive 2014/53/EU

For RE-Directive 2014/53/EU

All operational modes:

The adapter shall be installed near the equipment and shall be easily accessible.

2.4GHz:802.11b,802.11g,802.11n-20,802.11n-4,Bluetooth

5GHz:802.11a,802.11ac-20,802.11ac-40,802.11ac-80,802.11ac-160

5.8GHz:802.11ax-20,802.11ax-40,802.11ax-80,802.11ax-160

6GHz:802.11ax-20,802.11ax-40,802.11ax-80,802.11ax-160

The frequency and the maximum transmitted power in EU and UK are listed below:

2400-2485MHz:20 dBm

5150-5250MHz:23 dBm

5470-5725MHz:23 dBm

5725-5875MHz:13.95 dBm

5945-6425MHz:23 dBm

This device operates in the 5150-5350MHz and 5925-6425MHz frequency range and is restricted to indoor use only. Outdoor operation in this range is prohibited.

SAR/DAS refers to the rate at which the body absorbs RF energy.

The SAR limit set by the ICNIRP Guidelines is 2.0 W/kg(10g).

Testing for SAR is conducted using standard operating positions accepted by the EN standard.

During testing, the radio is set to its highest transmission levels and placed in positions that simulate use against the body.

This product is compliant with ICNIRP Guidelines with respect to Electromagnetic Fields (EMF) which specifies a Specific Absorption Rate (SAR) limit of 2W/kg. DAS\*/SAR: 0.672W/kg (corps/body)

---



#### Rechargeable Battery Notice

Do not

1. Throw into fire or a hot oven, or mechanically crush or cutting of a BATTERY
2. Throw or immerse into water
3. Heat to more than 60°C
4. Repaire or disassemble
5. Leave in an extremely low air pressure environment
6. Leave in an extremely high-temperature environment

A power cord is connected to a socket-outlet with earthing connection.



The unit can be operated at an ambient temperature of max. 35°C (95°F). Do not subject it to temperatures below 5°C (41°F) or above 40°C (104 °F).

**CAUTION: RISK OF EXPLOSION IF BATTERY IS REPLACED BY AN INCORRECT TYPE DISPOSE OF USED BATTERIES ACCORDING TO THE INSTRUCTIONS.**

---



#### PREVENTION OF HEARING LOSS



**CAUTION:** Listening to music at high volume levels and for extended durations can damage one's hearing. In order to reduce the risk of damage to hearing, one should lower the volume to a safe, comfortable level, and reduce the amount of time listening at high levels. Headsets should comply with EN 50332-2 requirements.

---

# FCC Information

## FEDERAL COMMUNICATIONS COMMISSION INTERFERENCE STATEMENT

This equipment has been tested and found to comply with the limits for a Class B digital device, pursuant to part 15 of the FCC Rules. These limits are designed to provide reasonable protection against harmful interference in a residential

installation. This equipment generates, uses and can radiate radio frequency energy and, if not installed and used in accordance with the instructions, may cause harmful interference to radio communications. However, there is no guarantee that

interference will not occur in a particular installation. If this equipment does cause harmful interference to radio or television reception, which can be determined by turning the equipment off and on, the user is encouraged to try to correct the

interference by one or more of the following measures:

- Reorient or relocate the receiving antenna.

- Increase the separation between the equipment and receiver.

- Connect the equipment into an outlet on a circuit different from that to which the receiver is connected.

- Consult the dealer or an experienced radio/ TV technician for help.

## RF Exposure Information(SAR)

This device meets the government's requirements for exposure to radio waves. This device is designed and manufactured not to exceed the emission limits for exposure to radio frequency (RF) energy set by the Federal Communications Commission of the U.S. Government.

The exposure standard employs a unit of measurement known as the Specific Absorption Rate, or SAR. The SAR limit set by the FCC is 1.6 W/kg. Tests for SAR are conducted using standard operating positions accepted by the FCC with the EUT transmitting at the specified power level in different channels.

The FCC has granted an Equipment Authorization for this device with all reported SAR levels evaluated as in compliance with the FCC RF exposure guidelines. SAR information on this device is on file with the FCC and can be found under the Display Grant section of [www.fcc.gov/eot/ea/fccid](http://www.fcc.gov/eot/ea/fccid) after searching on

FCC ID:2BLG8AX211NG

This device complies with Part 15 of the FCC Rules. Operation is subject to the following two conditions:

- (1) this device may not cause harmful interference, and
- (2) this device must accept any interference received, including interference that may cause undesired operation.



CAUTION: Any changes or modifications not expressly approved by the grantee of this device could void the user's authority to operate the equipment.

---

## 1.2 Safety Instructions



Please read the safety instructions carefully. All cautions and warnings on the equipment or user's manual should be noted.



DO NOT place the product in unstable surfaces which could lead the product to fall and cause damage to the product.



DO NOT block the rear/bottom air vents of the product to ensure proper cooling of the product during usage.



DO NOT place heavy objects on the product.



DO NOT cover the product or the AC Adapter with any objects.



DO NOT expose the product to direct sunlight for long periods of time, this is to ensure that the product is working in optimal condition.



DO NOT leave or place the power cord of the adapter where it can cause others from tripping over them.



DO NOT use or expose the product to environments with magnetic interference, as it may prevent the product from.



DO NOT expose to liquids, rain, or using the product in high moisture environments to prevent the risks of damaging the product.



DO NOT use the product during electrical storms to avoid the risk of electric shock or short circuiting.



DO NOT use chemical substances to clean any part of the product to prevent potential damage.

## 1.3 Conventions for this Manual

---



CAUTION : This message contains important information that must be followed for safe operation.

---



NOTE: This message contains information for special situations.

---

## 1.4 Release History

Version	Date	Revision Note
1.0	06/2025	Initial release

---

## Chapter 2

# Getting to know the basics

## 2.1 Product Specification

This User's Manual provides technical information of instructions and illustrations on how to operate this notebook for the customer. Please read this manual carefully before using this notebook.

### · Physical Characteristic

#### ■ Dimension

357.3 x 258.98x 22.5mm  $\pm$ 1%

Weight:2.25Kg +/- 5% (depend upon the actually shipping product)

### · CPU

#### ■ Support Processor

Intel Raptor Lake HX55 / Intel Raptor Lake Refresh HX55

### · GPU

#### ■ Support Processor

NVIDIA GN22

### · Memory

#### ■ RAM

DDR5 4800MHz(13700HX)

DDR5 5600MHz(14650HX)

### · Display

#### ■ LCD

16",16:10 Bent

2.5K 2560x1600

QHD 2.5K,300Hz,sRGB100%,500nits

QHD 2.5K,180Hz,sRGB100%,500nits

QHD 2.5K,300HZ,DCI-P3,500nits

## · I/O Port

DC-in	x 1
USB	USB-A @Left x1 (USB3.2 Gen1, 5Gbps) USB-A @Right x2 (USB3.2 Gen1, 5Gbps) USB-C @Rear x1 (USB3.2 Gen2, 20Gbps+DP1.4+PD140W) support 20V only USB-C @Left x1 (USB3.2 Gen2, 10Gbps+DP1.4+PD100W) support 20V only
Mini DP	x 1
RJ45	x 1
HDMI	x 1 V2.1 (dGPU, FRL-12G, 48Gbps)
3.5mm UAJ Jack	x 1

---

CAUTION: To prevent system overload, Type-C is prohibited from being under load when using a 100W PD charger

## · Audio

### ■ Codec

---

CX11880  
Speaker Type:2514  
Nahimic

### ■ Speaker/MIC

---

Build-in 2 speakers  
Speaker : 2W/each

## · Webcam

### ■ Infrared capability for facial recognition camera (Option)

---

HD Camera D-MIC x1, 4mm

HD +IR Camera D-MIC x2, 4mm (Option)

FHD+IR Hybrid Camera D-MIC x2, 4mm (Option)

FHD & IR dual-sensor D-MIC x2, 4mm (Option)

## · Communication Port

### ■ Wireless LAN +BT

---

M.2 2230 with CNVI interface

Intel Wi-Fi 6E AX211/AX201 (only for MR)

IEEE802.11 a/b/g/n/ac/ax support

### ■ LAN

---

Supports 10/100/1000 Mb/sec

## · Input

### ■ Keyboard

---

Membrane with Full-Num

travel =  $1.4 \pm 0.2$  mm

Backlit = Single Zone RGB

Backlit = Perkey RGB (Option)

### ■ Pointing Device

---

TDA2174: 121.2 x 74.9 mm

Mylar / Glass-Like

Support palm rejection

## Power

### ■ AC Adapter

---

Automatic Voltage adjustment between 100 and 240VAC 50/60Hz,

210 Watts (20V/10.5A), 3 Pins

250 Watts (20V/12.5A), 3 Pins (option)

### ■ Battery (By model)

---

Li- polymer Battery, SW Gas Gauge IC, soft pack,

4S1P 5200mAh 80Wh



CAUTION: MODEL IS DESIGNED TO USE WITH THE

DC INPUT: 210 Watts (20V/10.5A)/250 Watts (20V/12.5A)(option)

---

## 2.2 Preparing your Computer

- A** Connect the AC adapter's DC output plug to the DC IN jack.

The first time to use, the computer will take a long time to boot up, please wait patiently.

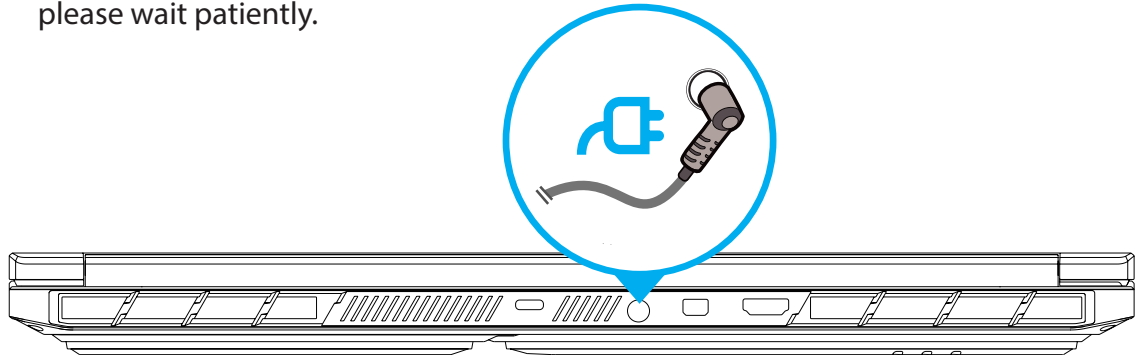

- B** The display panel can be opened to a wide range of angles for optimal viewing.

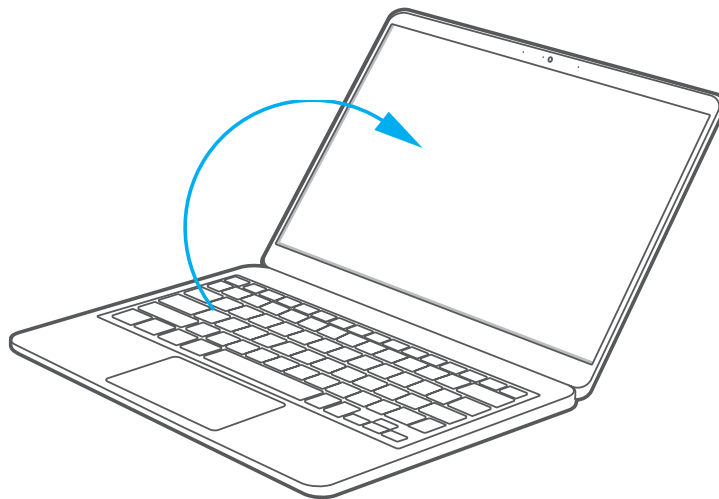

- C** Press the power button to turn on your notebook computer.

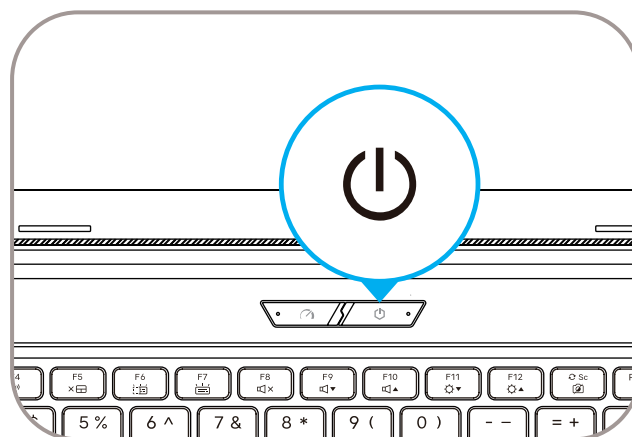

## 2.3 Product Overview

Please become familiar with each component before you operate the computer.

### Top-Open View



NOTE: The product's color/ LED color, I/O port, indicator location, and specification will depend upon the actually shipping product.

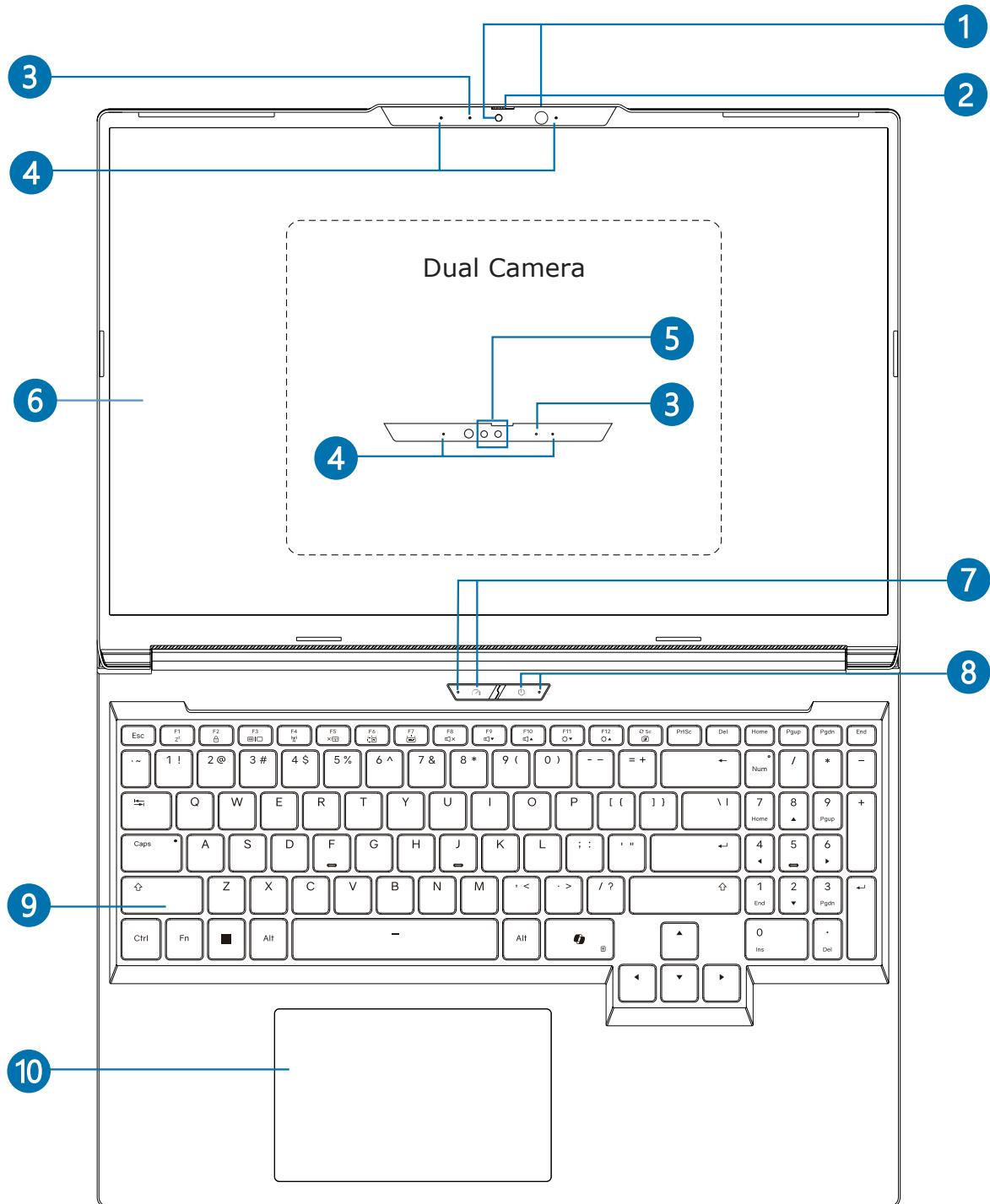

## 1 Camera

A device that allows you to record video or take photographs with your computer.

### **Infrared capability for facial recognition camera (Option)**

can be used to identify and authenticate user to unlock notebook, conduct payment and other security functions.

## 2 Shutter latch

Use Shutter latch to close the camera to protect privacy.

## 3 Camera status LED

The Camera Status LED shows the Camera status.

## 4 Microphone

Built-in microphones.

MIC\*2

## 5 Dual camera (option)

A device that allows you to record video or take photographs with your computer.

## 6 LCD display

Displays of your notebook computer.

## **7 Custom / Turbo / Balance / Office mode switch**

Office mode: Green always on

Balance mode: Blue always on

Turbo mode: Purple always on

Custom mode: White always on

## **8 Power button**

Press this button to turn the computer's power on or off.

### **Power indicator**

No charging:

Power ON: Blue

Power Off: OFF

## **9 Keyboard**

The keyboard is designed with comfortable key travel distance which provides a smooth and responsive typing experience.

## **10 Touchpad/Click pad**

Touch-sensitive pointing device which functions like the mouse.



**CAUTION:**When you are not using the computer, keep the LCD screen closed to protect it from dust.

---

## Right Side View

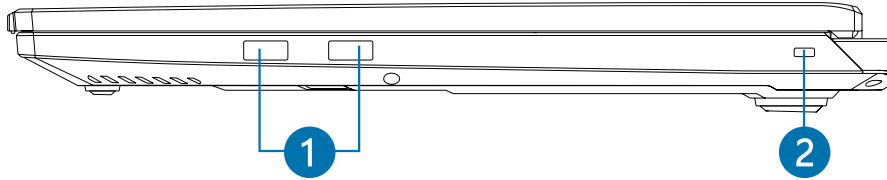

### 1 USB port

Connects a USB device (such as USB Zip drive, keyboard or mouse) into this jack. With charging function.

### 2 Kensington® lock port

To be secured using Kensington® Lock Port security products.

## Left Side View

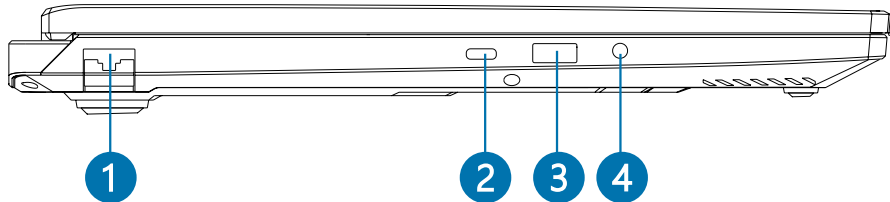

### 1 Network jack

This jack lets you connect to a LAN.

### 2 USB port (Type C)

Connects a USB device.

With PD 100W supported and charging function (support 20V only).

### 3 USB port

Connects a USB device (such as USB Zip drive, keyboard or mouse) into this jack.

### 4 3.5mm UAJ jack (Combo jack)

Connect the 3.5mm audio combo jack/headphones to this port.

## Bottom Side View



NOTE: The product's thermal vent will depend upon the actually shipping product.

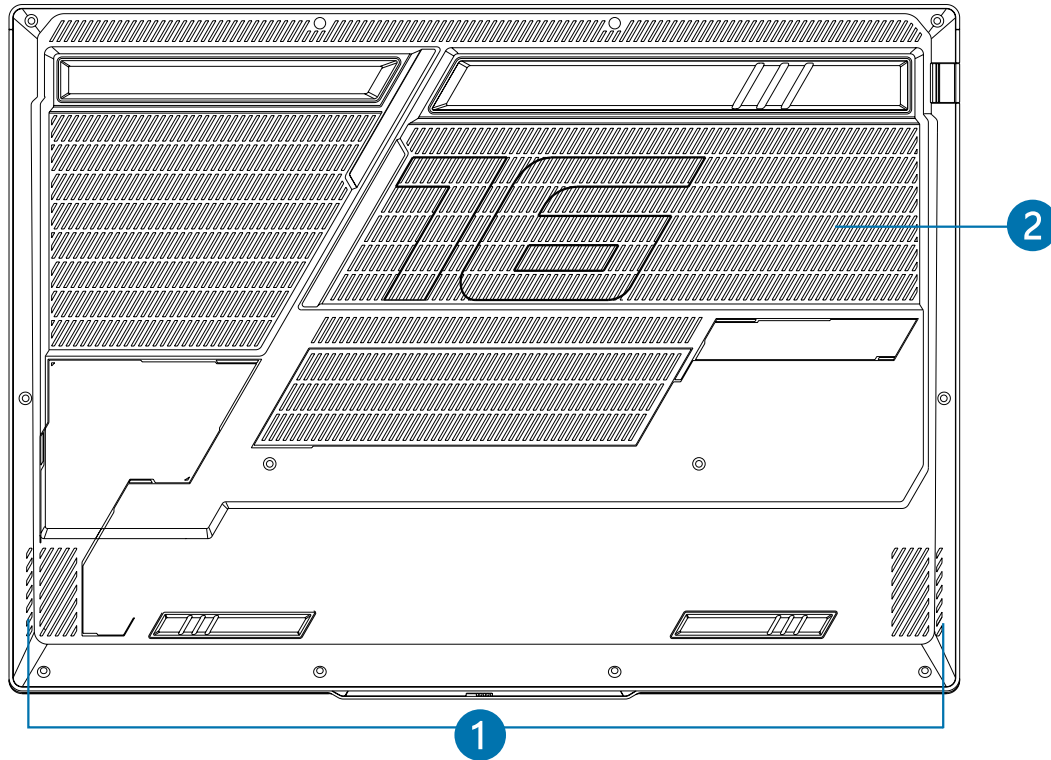

### 1 Speaker

### 2 Vents

The thermal vents are designed to cool the internal components and avoid overheating.



**CAUTION:** To reduce the possibility of heat-related injuries or of overheating the computer, do not place the computer directly on your lap or obstruct the computer air vents. Use the computer only on a hard, flat surface. Do not allow another hard surface, such as an adjoining optional printer, or a soft surface, such as pillows or rugs or clothing, to block airflow. Also, do not allow the AC adapter to come into contact with the skin or a soft surface, such as pillows or rugs or clothing, during operation.

## Compartment View



NOTE: Specification will depend upon the actually shipping product.

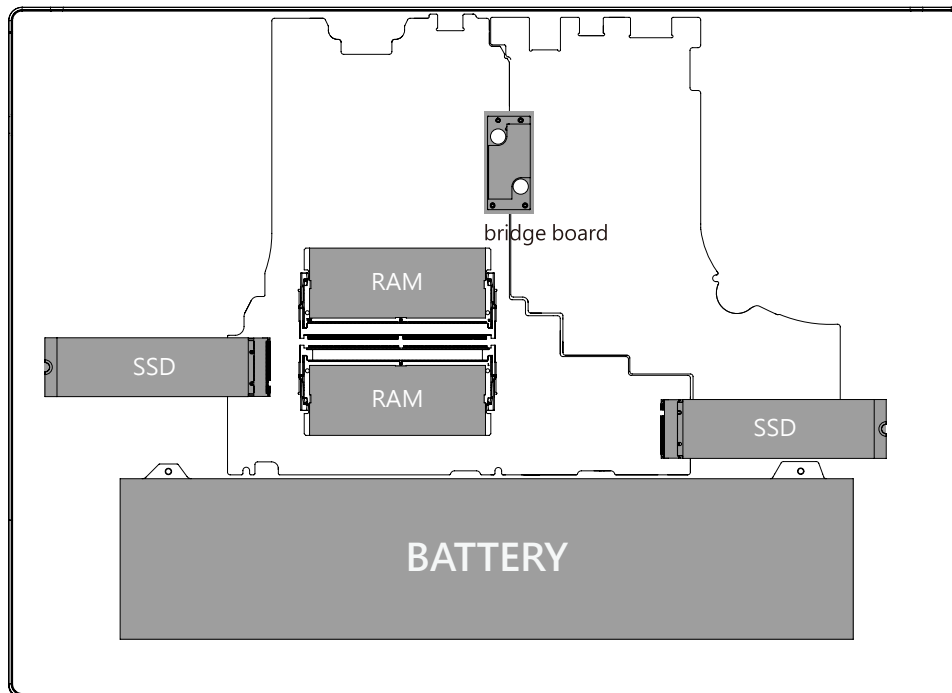

Please contact technical support team and after-sales service for any technical issues.



Do not dismantle the interior components (eg. Bridge board....etc) as this may result in severe consequences such as electrical short circuit and possibility of high temperature oxidation which will void the warranty.

# Front Side View

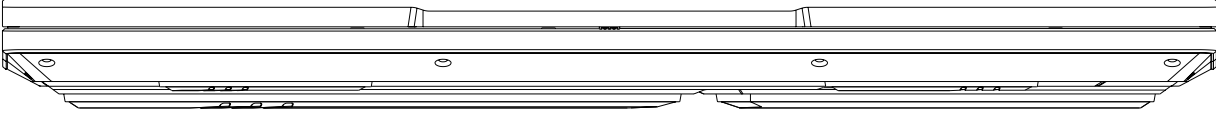

# Back Side View

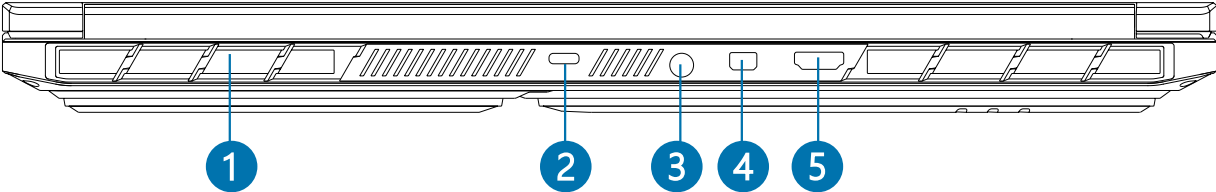

**1 Vents**

The thermal vents are designed to cool the internal components and avoid overheating.

**2 USB port (Type C)**

Connects a USB device.  
( w/ PD 140W supported) and With charging function (support 20V only).

**3 DC power jack**

Connects the AC adapter into this connector.

**4 Mini display port**

Supports high-definition digital video connections.

**5 HDMI port**

Connected to the screen, or home theater system.

## Features

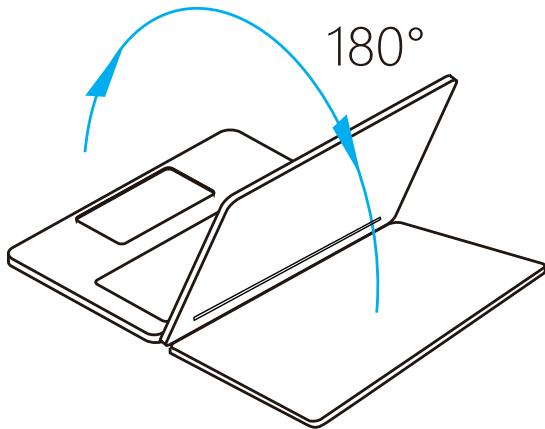

Rotate 180 degrees to share screen images.

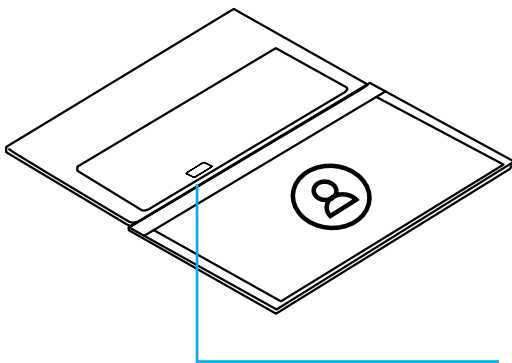

Press button  Sc  
can rotate the screen image

## Chapter 3

# Getting started

## 3.1 AC Adapter

Please be noted that it is strongly recommended to connect the AC adapter and use the AC power while using this notebook for the first time. When the AC adapter is connected, the battery is being charged immediately. Attach the AC adapter when you need to charge the battery or you want to operate from AC power. It is also the fastest way to get started, because the battery pack will need to be charged before you can operate from battery power.

Note that the AC adapter included in the package is approved for your notebook; using other adapter model may damage either the notebook or other devices attached to it.

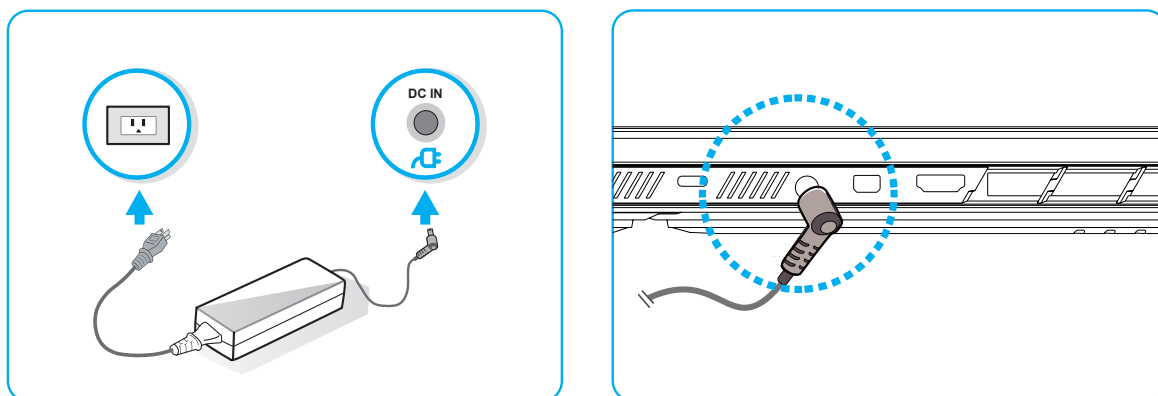

**CAUTION:** The use of inferior extension cords may result in damage to your notebook. Your notebook comes with its own authorized AC adapter. Use of a different AC adapter or cable extension which is not authorized for use will void warranty protection if damage to hardware is found in association to said adapter or extension cable.











**NOTE:** The power adapter can become hot when in use. Please be sure the AC adapter is not covered with any materials keep it away from exposed parts of your body. The AC adapter appearance may vary depending on your region.

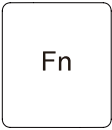
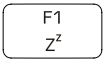
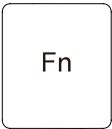

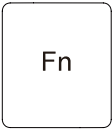



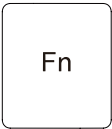





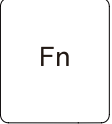
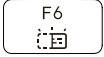
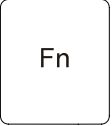

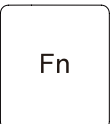
## 3.2.1 For keyboard users

To activate these functions, press the hot key associated with the desired function as below :

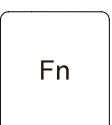

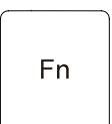

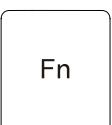
### Function Keys

Keypad	Function Description
 +  Suspend:	Press this key combination (Fn+F1) to enter sleep mode.
 +  Windows Lock/On:	Press this key combination (Fn+F2) to turn Windows Lock/On .
 +  Display mode:	Press this key combination (Fn+F3) to enable Display Mode.
 +  RADIO On/Off:	Press this key combination (Fn+F4) to turn all radios on or off.
 +  Touch pad On/Off:	Press this key combination (Fn+F5) to On/Off Touch pad mode.

# Function Keys

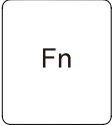
Keypad	Function Description
 +  Keyboard Brightness down:	Press this key combination (Fn+F6) to decrease brightness of Keyboard.
 +  Keyboard Brightness up:	Press this key combination (Fn+F7) to increase brightness of Keyboard.
 +  MUTE:	Press this key combination (Fn+F8) to enter MUTE mode.
 +  Volume down:	Press this key combination (Fn+F9) to enter Volume down mode.
 +  Volume up:	Press this key combination (Fn+F10) to enter Volume up mode.
 +  Brightness down:	Press this key combination (Fn+F11) to decrease brightness of LCD display.
 +  Brightness up:	Press this key combination (Fn+F12) to increase brightness of LCD display.

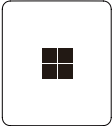
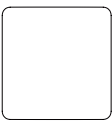
# Function Keys

Keypad	Function Description
 +  Camera On/Off:	Press this key to On/Off camera function.
 +  Search Charm : (Option)	For a full list of Windows keyboard shortcuts, please visit the Microsoft official website <a href="https://support.microsoft.com/en-us/">https://support.microsoft.com/en-us/</a>
	Enable Copilot on Windows Copilot will be displayed on the right side of the computer, Copilot supports pictures , voice, text and other chat methods.

### 3.3 Using the touchpad / clickpad

The touchpad / clickpad is a rectangular electronic panel located just below your keyboard. You can use the buttons below the touchpad as left and right mouse buttons.

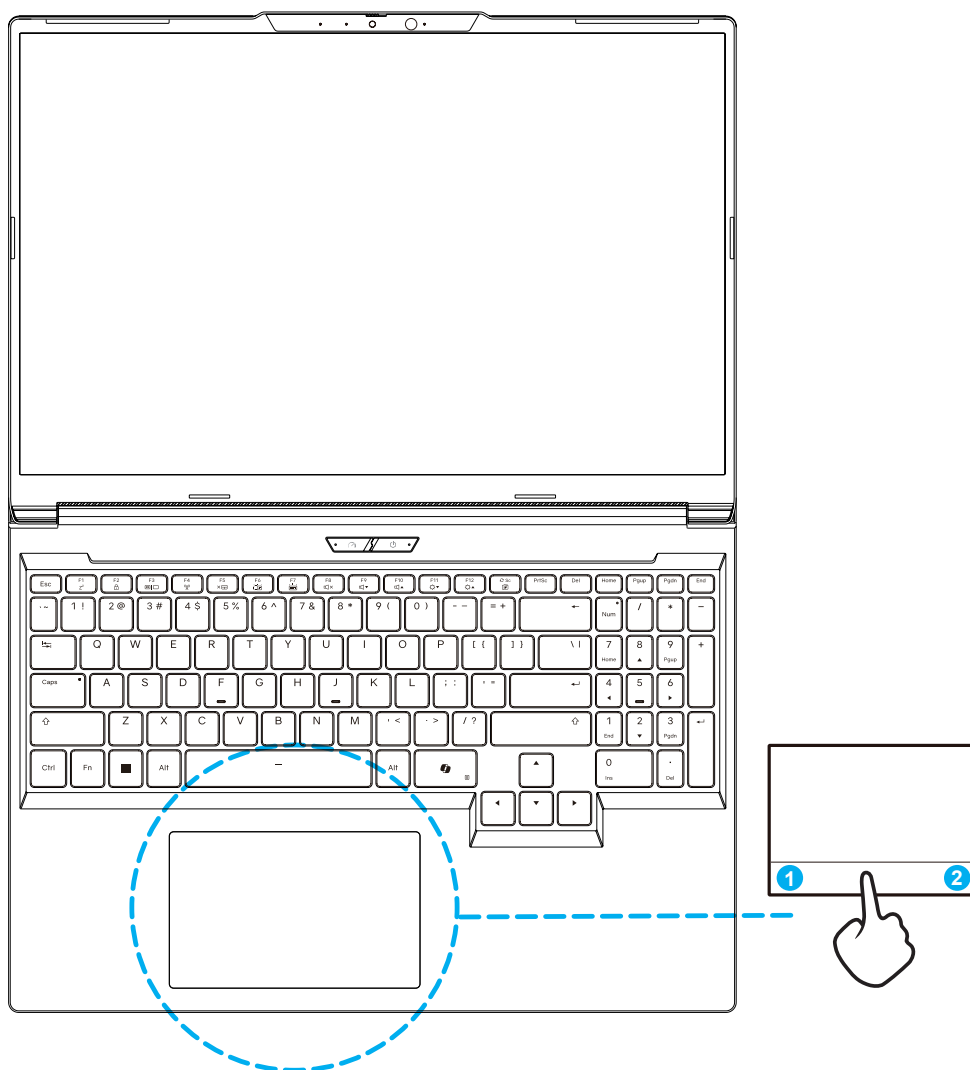

Press the left **1** and right **2** buttons located on the edge of the touchpad / clickpad to make selections and run functions. These two buttons are similar to the left and right buttons on a mouse. Tapping on the touchpad / clickpad produces similar results.

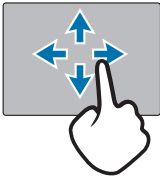
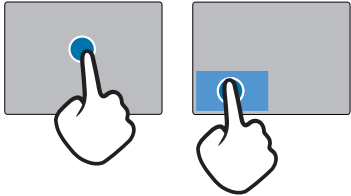
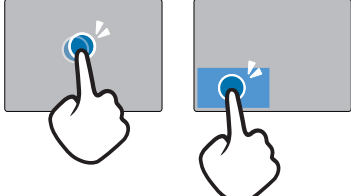
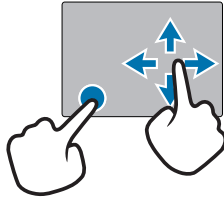

# Touchpad usage

Finger gesture	Function description
	<p><b>Cursor Movement</b></p> <p>Slide with 1-finger to move the cursor.</p>
	<p><b>Selecting an item</b></p> <p>Tap with 1-finger to select an item.</p>
	<p><b>Executing or opening a folder</b></p> <p><b>Method 1 :</b> Double Tap with 1-finger to execute a program and/or opening a folder.</p> <p><b>Method 2 :</b> Press down on the bottom left of the trackpad until you hear a click.</p>
	<p><b>Multiple item selection</b></p> <p><b>Method 1 :</b> Hold down with 1-finger on the left click button and slide to make multiple selections.</p> <p><b>Method 2 :</b> Hold down with 1-finger on the left click button and use another finger to slide to make multiple selections.</p> <p><b>Method 3 :</b> Double Tap and hold down with 1-finger on a open space on the screen and drag to make multiple selections.</p>

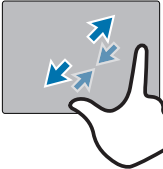
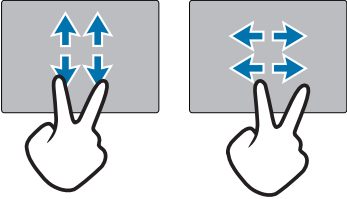
# Touchpad usage

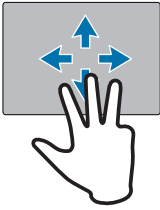
Finger gesture	Function description
	<p><b>Zoom in/out</b> Using 2-fingers: pinch to zoom in / spread to zoom out.</p>
	<p><b>Page Scrolling &amp; Next or Prev. page/image</b> Use 2-fingers and slide them up or down the Touchpad/Trackpad to do page scrolling (page up/down). Use 2 fingers and slide them left or right the Touchpad/Trackpad to do next/previous images or pages.</p>
	<p><b>“Windows search”</b> Tap with 3-fingers to bring up Windows Search.</p>
	<p><b>Desktop View and Task View</b> Slide up with 3-fingers to bring up Task View. Slide down with 3-finger to minimize all windows and back to Desktop.</p>

## Chapter 4

# BIOS setup

## 4.1 About BIOS Setup

### 4.1.1 When to Use BIOS Setup ?

You may need to run the BIOS Setup when:

- An error message appears on the screen during the system booting up and is requested to run SETUP.
- You want to change the default settings for customized features.
- You want to reload the default BIOS settings.

### 4.1.2 How to Run BIOS Setup ?

To run the BIOS Setup Utility, turn on the notebook and press the [Del] key during the POST procedure.

If the message disappears before you respond and you still wish to enter Setup, either restart the system by turning it OFF and ON, or simultaneously pressing [Ctrl]+[Alt]+[Del] keys to restart.

Be noted that the screen snaps and setting options in this chapter are for your references only. The actual setting screens and options on your Notebook may be different because of BIOS update.

The setup function only can be invoked by pressing [Del] or [F2] key during POST that provide a approach to change some setting and configuration the user prefer, and the changed values will save in the NVRAM and will take effect after the system rebooted. The setup uses a menu interface to allow the user to configure their system and the features are briefly listed as follow.

Press [F7] key for Boot Menu.



NOTE : The drivers, BIOS and utilities bundled in the support DVD may vary by models and are subject to change without notice

---

## 4.2 BIOS Setup Menu

Once you enter the BIOS Setup Utility, the Main Menu will appear on the screen. Select the tags to enter the other menus.

### Main Menu

Show system overview about memory size and setting of system time and date.

### Advanced Menu

Display device information and advanced setting items.

### Security Menu

Install or clear the password settings for supervisor and user.

### Boot Menu

Configure Settings during System Boot.

### Exit Menu

Save or discard the changes before leaving the BIOS Setup Menu.

## 4.2.1 Main Menu



### · System Time

This item allows you to set the system time. There is a small internal (CMOS) battery which is designed to maintain your system clock. It is designed to maintain time even when the PC is powered down or in sleep mode. The time format is [hour:minute:second].

Use [+] or [-] to configure system Time.

### · System Date

This item allows you to set the system date. The date format is [day:month:date:year].

Use [ENTER], [TAB] or [SHIFT-TAB] to select a field.

---

Month (Month)	The month from 01 (January) to 12 (December).
---------------	---

---

Date (Date)	The date from 01 to 31.
-------------	-------------------------

---

Year (Year)	The year can be adjusted by users.
-------------	------------------------------------

---

· **Processor Type:**

{ Brand information of installed processor }

· **Processor Speed:**

{ Current Processor Speed, unit is MHz }

· **Total Memory:**

{ The size of total installed memory, unit is MB }

· **Memory Frequency:**

{ Current Memory Speed, unit is MT/s }

· **Memory Slot Information:**

{ Current Memory Slot Information, Vendor, Part number... }

## 4.2.2 Advanced Menu

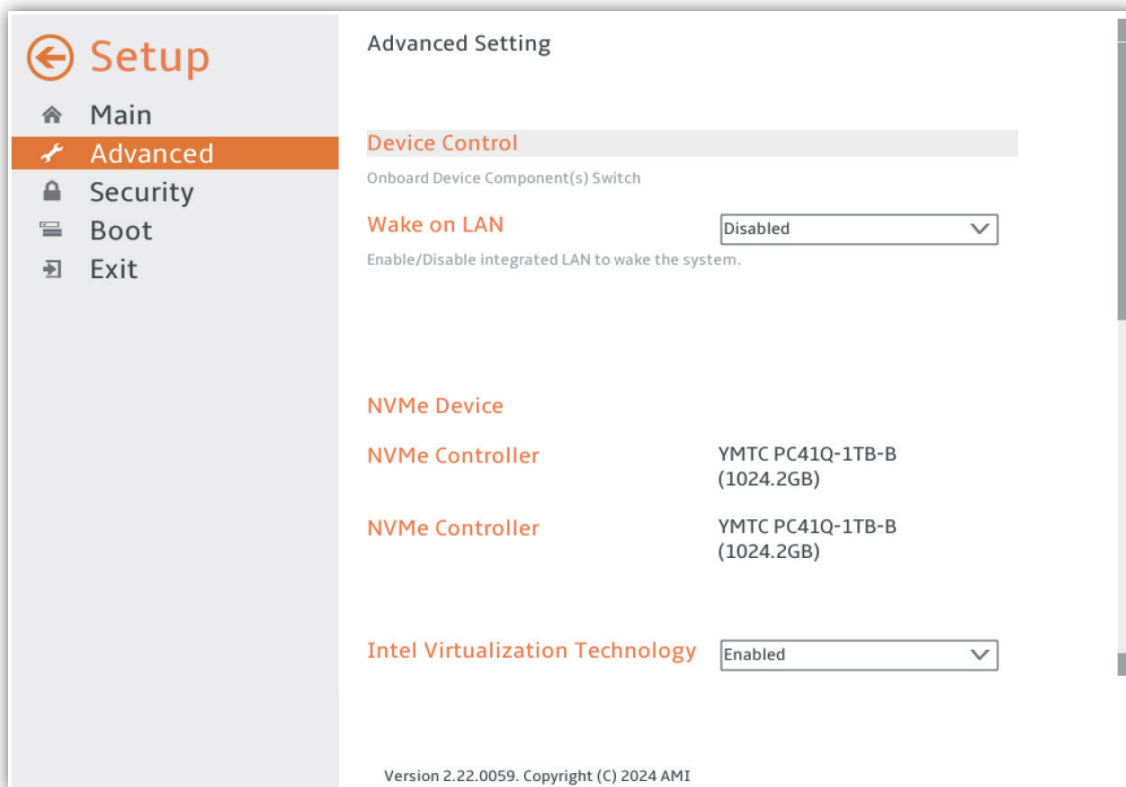

- **Device Control**

Onboard Device Component(s) Switch and may include the following: Webcam/Wi-Fi/Bluetooth/HD Audio/Onboard LAN/Card Reader/USB.....

- **Wake on LAN**

Enable/Disable integrated LAN to wake system.

- **NVME Device**

NVME SSD info will be displayed

- **Intel Virtualization Technology**

[Enabled/ Disabled] Intel Virtualization Technology

- **Display Mode**

Contains the Switchable graphics options

## 4.2.3 Security Menu

The screenshot shows the 'Security Settings' menu. On the left is a navigation pane with 'Setup' at the top and options: Main, Advanced, Security (highlighted), Boot, and Exit. The main area is titled 'Security Settings' and contains the following items:

- Access Level**: Administrator
- Administrator Password**: Not Installed
- User Password**: Not Installed
- Change Administrator Password -Not Installed**: Set Setup Administrator Password
- Change User Password -Not Installed**: Set User Password
- Password Login Control**: Both (dropdown menu)

Enables password entry on boot, setup page, or both.

Version 2.22.0059. Copyright (C) 2024 AMI

The screenshot shows the 'Vendor Keys' menu. On the left is a navigation pane with 'Setup' at the top and options: Main, Advanced, Security (highlighted), Boot, and Exit. The main area is titled 'Vendor Keys' and contains the following items:

- Factory Key Provision**: Enabled (dropdown menu)
- Restore Factory Keys**: Force System to User Mode. Install factory default Secure Boot key databases
- Reset To Setup Mode**: Delete all Secure Boot key databases from NVRAM

**Secure Boot variable** | Size| Keys| Key Source

**Platform Key** (PK)| 866| 1| Factory

Enroll Factory Defaults or load certificates from a file:

- Public Key Certificate:
  - EFI\_SIGNATURE\_LIST
  - EFI\_CERT\_X509 (DER)
  - EFI\_CERT\_RSA2048 (bin)
  - EFI\_CERT\_SHAXXX

Version 2.22.0059. Copyright (C) 2024 AMI

- Change Administrator Password

When this item is selected, a message box shall appear on the screen as below:

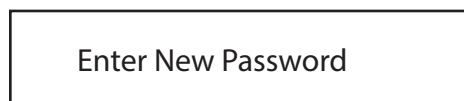

Enter New Password

Type a maximum of 20-digit password and press [Enter].

The password typed now will replace any previously set password from CMOS memory. You may also press [ESC] to abandon new password setting. It is extremely important to keep record for any BIOS password which is set as it can not be reset even with the removal of a CMOS battery for the security of your PC.

Select Change User Password to give or to abandon password setting same as Change Administrator Password item above.

Note that Administrator Password field allows users to enter and change the settings of the BIOS SETUP UTILITY, while User Password field only allows users to enter the BIOS SETUP UTILITY without having the authorization to make any change.

The Password Check item is used to specify the type of BIOS password protection that is implemented.

To clear a set Administrator Password/ User Password, just press [Enter] under Change Administrator Password/ Change User Password field when you are prompted to enter the password. A message box will pop up confirming password will be disabled. Once the password is disabled, the system will boot and user can enter setup without entering password.

#### Key Management:

Enables expert user to modify Secure Boot Policy variables without full authentication.

## 4.2.4 Boot Menu

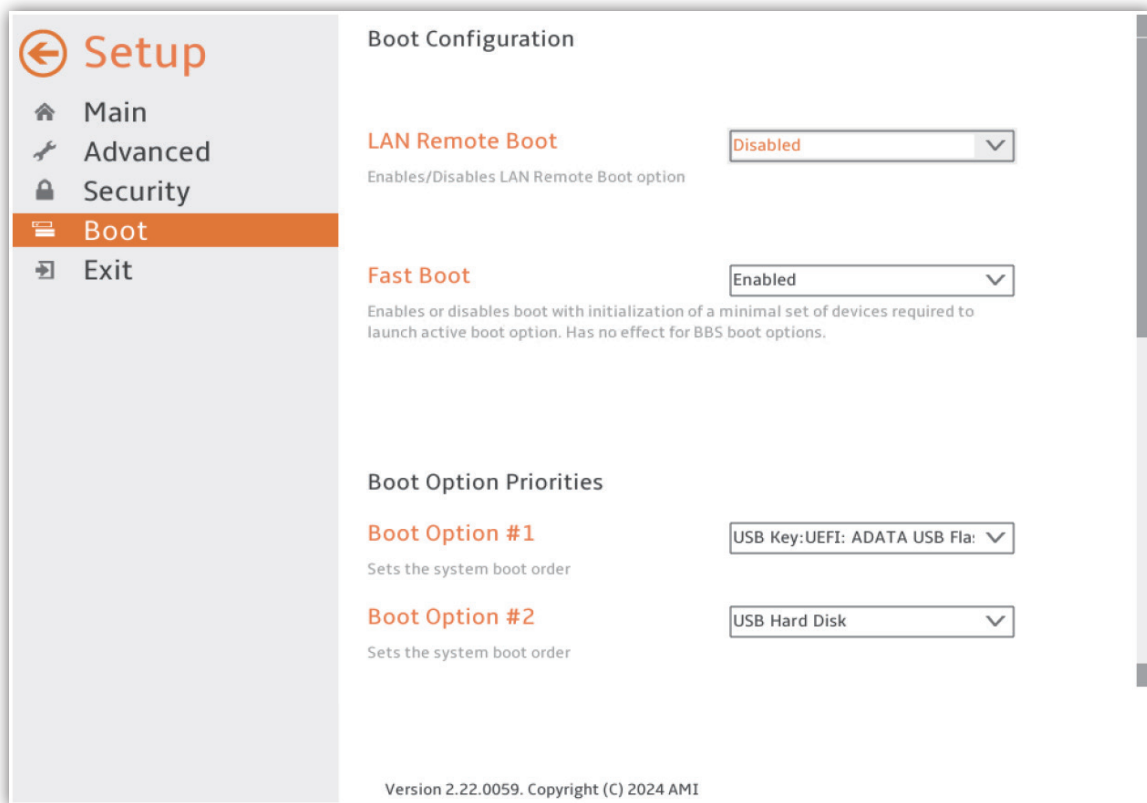

- **Boot Configuration**  
Configure Settings during System Boot.
- **Set Boot Priority (1st/2nd/3rd/..... Boot)**  
Specifies the boot sequence from the available devices.  
A device enclosed in parenthesis has been disabled in the corresponding type menu.
- **Hard Disk Drive / USB HardDisk Drive**  
Specifies the Boot Device Priority sequence.
- **Fast Boot: [Enabled/ Disabled]**

## 4.2.5 Exit Menu

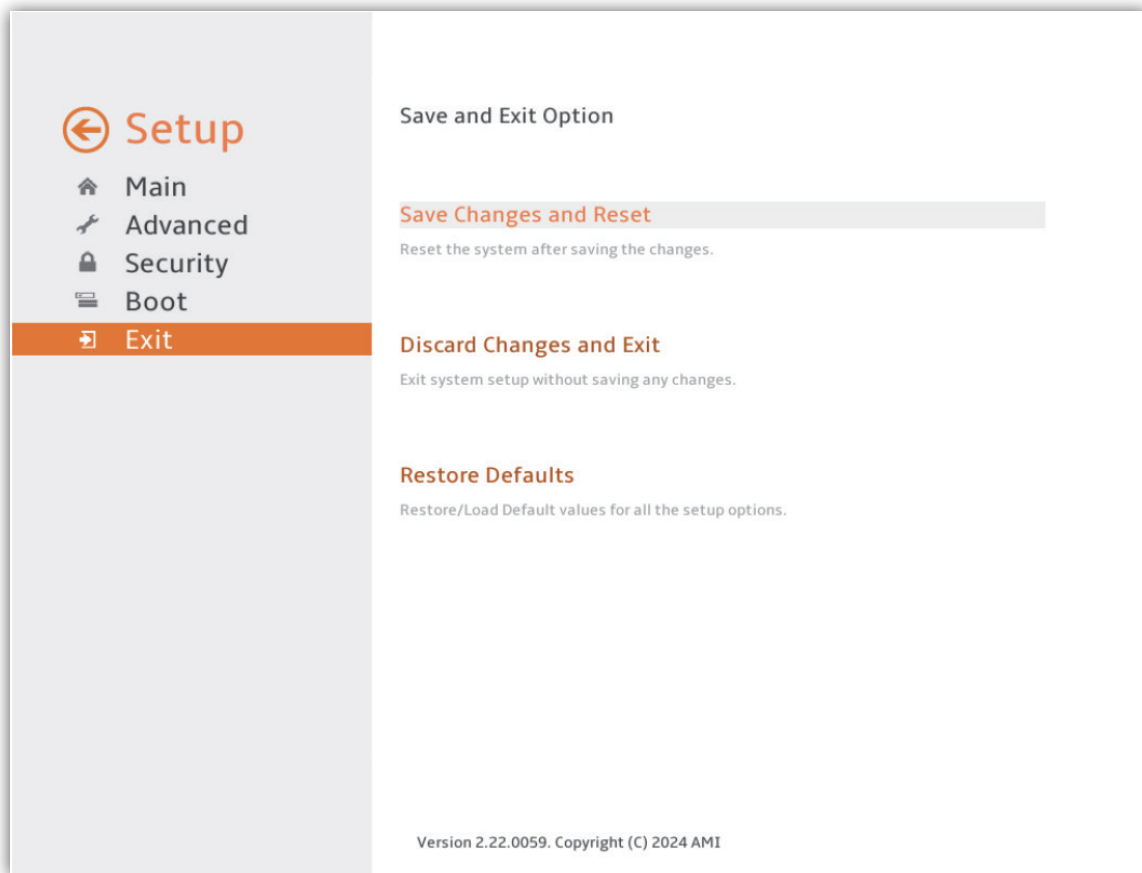

- **Save Changes and Reset**

Exit system setup after saving the changes.F10 key can be used for this operation.

- **Discard Changes and Exit**

Exit system setup without saving any changes.

ESC key can be used for this operation.

- **Restore Defaults**

Restore/Load Defaults values for all the setup options.F9 key can be used for this operation.